

DA

CAST IRON / DUCTILE IRON MANHOLE COVERS AND FRAMES (SS 30 , BS EN 124)

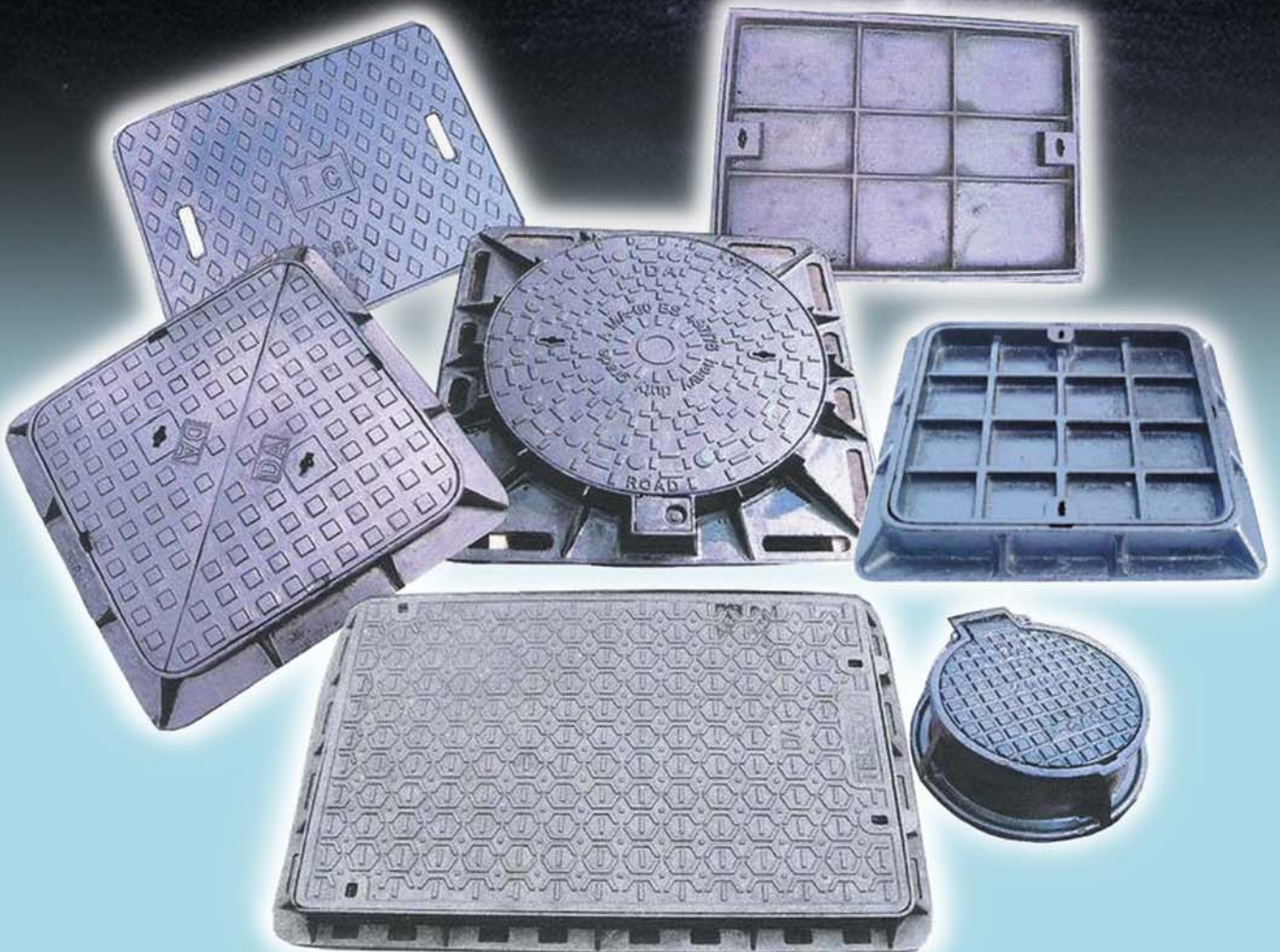

PSB Tested and Approved "DA" Brand Manhole and Surface Covers with Frames are available in both Cast Iron and Ductile Iron. Our Manhole Covers are made of Ductile Iron which have Excellent Tensile Strength and Shock Load Resistance.



道遠私人有限公司

DUCTILE PTE LTD

No. 5 Defu Lane 6 Singapore 539367
Tel : (65) 6284 5511 Fax : (65) 6285 1930
Email : ductile@ductile.com.sg
<http://www.ductile.com.sg>

ISO 9001
BUREAU VERITAS
Certification



"DA" Brand Manhole Covers with Frames are made of High Quality Iron, used as Covers for Manholes in HDB Flats, Pavements and Roads with good properties in the resistance to Acid, Alkali and Abrasion. Beside, this material is still better than ordinary Mild Steel in the resistance against the corrosion of efflorescence in natural atmosphere.

Design	DA Covers incorporate a virtually unbreakable heavy gauge frame, which specially designed to provide a stable seating.
Standard / Strength	DA Covers and Frames which meets the Standard - (SS 30, BS EN 124) DA Covers and Frames Fullfill All Requirement Specifications. Moreover, designed to withstand loads under different loading requirements.
Protection / Appearance	DA Covers and Frames are furnished with good resistance against corrosion and abrasion. DA Covers and Frames are patterned with anti-slippery surface that does not compromise safety with appearance.

Design Load / Location of Installation

Grade	Design Load	Location of Installation
AA1	900 KN	Particular High Wheel Load (e.g. Aircraft Pavement) Special Requirement.
AA2	600 KN	High Wheel Load (e.g. Docks) Special Requirement.
A1	400 KN	Vehicular Wheel Load (e.g. Carriageways, Road Ways.)
A2	230 KN	Vehicular Wheel Load (e.g. Carriageways, Road Ways.)
A	350 KN	Vehicular Wheel Load (e.g. Carriageways, Road Ways.)
B	125 KN	Medium Duty (e.g. Footpaths, Grass Areas & Cycle Tracks)
C	15 KN	Light Weight (e.g. Footpaths)

GRADE C LIGHT DUTY CAST IRON INSPECTION CHAMBER COVER & FRAME

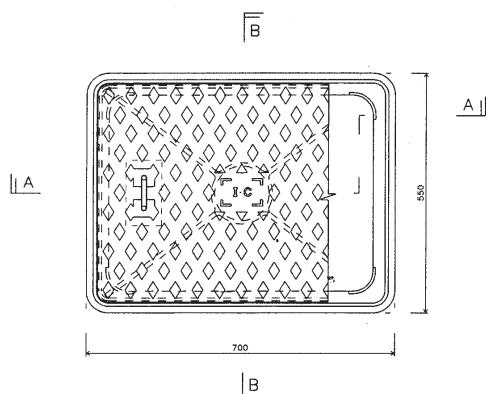
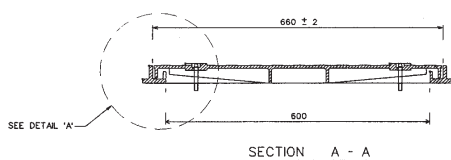

GRADE C LIGHT DUTY CAST IRON RECESSED INSPECTION CHAMBER COVER & FRAME

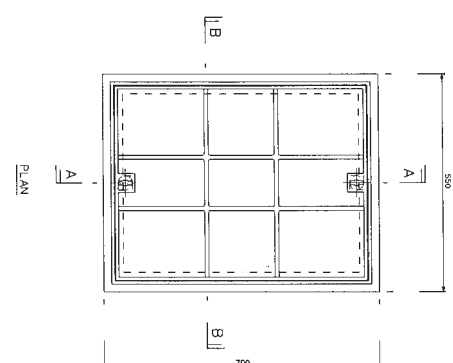
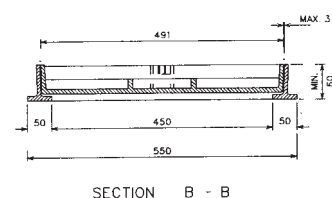

**GRADE B MEDIUM DUTY CAST IRON
MANHOLE COVER & FRAME**

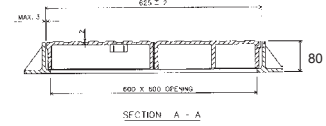
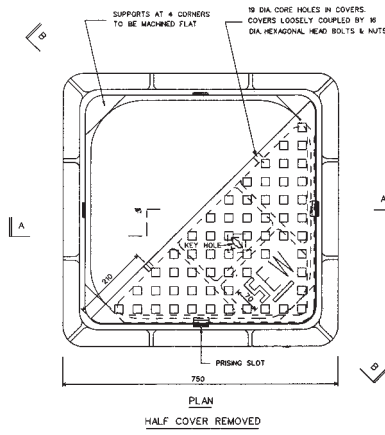
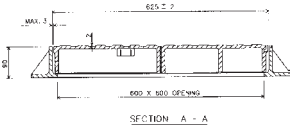

**GRADE A2 HEAVY DUTY CAST IRON
MANHOLE COVER & FRAME**

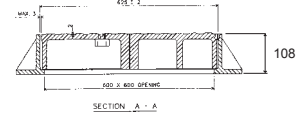
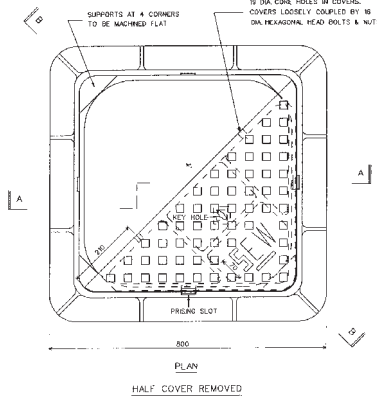
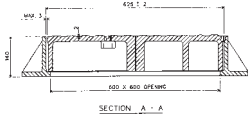
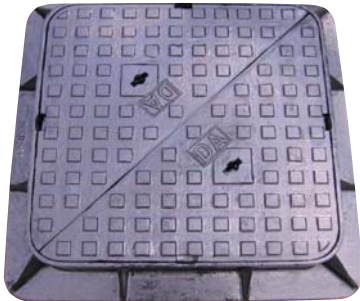

**GRADE A HEAVY DUTY DUCTILE IRON
SINGLE / DOUBLE SURFACE VALVE BOX**



SINGLE

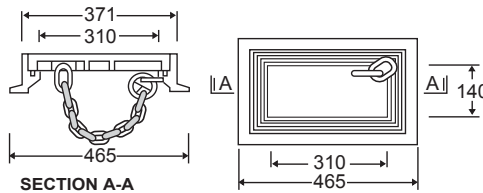

**GRADE A2 HEAVY DUTY DUCTILE IRON
ROUND SURFACE VALVE BOX**

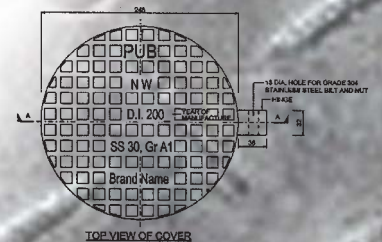

DOUBLE

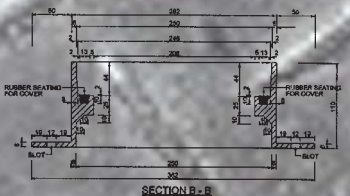
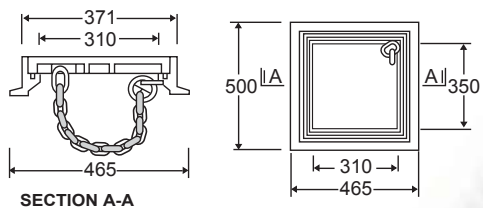

**GRADE A2 HEAVY DUTY CAST IRON
RECESSED
MANHOLE COVER & FRAME**

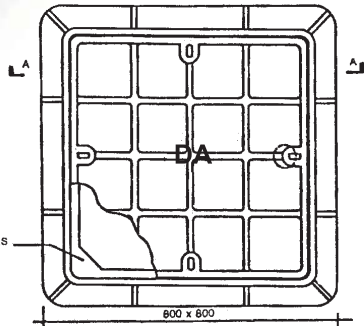
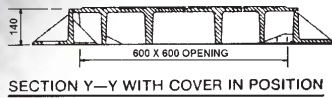

**GRADE A2 HEAVY DUTY
DUCTILE IRON
CIRCULAR COVER & SQUARE FRAME**

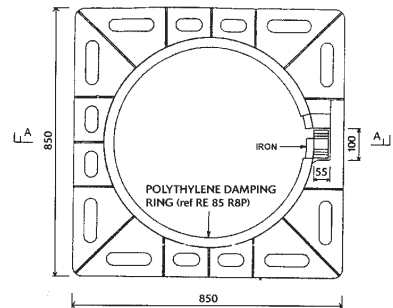
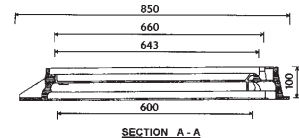

**GRADE B MEDIUM DUTY
DUCTILE IRON
TELECOM MANHOLE COVER & FRAME**

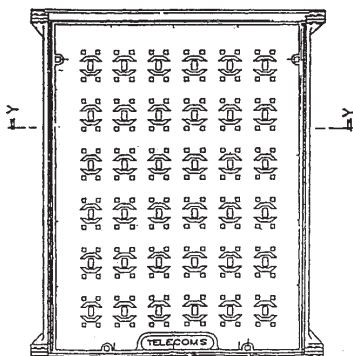
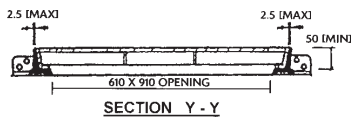

**GRADE A1 HEAVY DUTY
DUCTILE IRON
TELECOM MANHOLE COVER & FRAME**

